

# Lectures on accelerator physics

- Lecture 3 and 4: Examples
  - Examples of accelerators

# Rutherford's Scattering (1909)

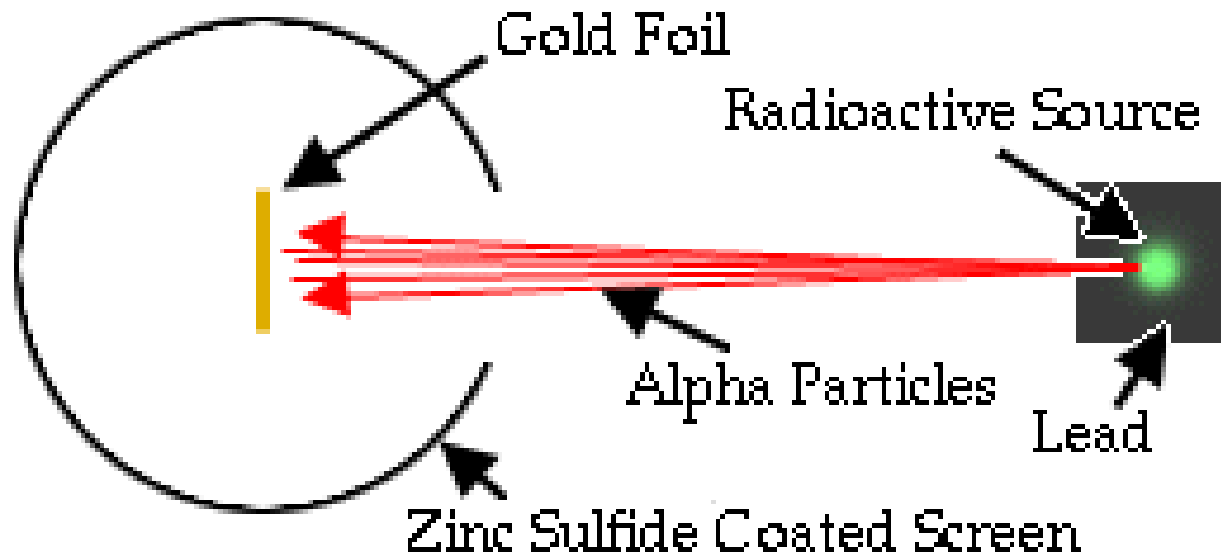

- Particle Beam
- Target
- Detector

# Results

The Predicted Result:

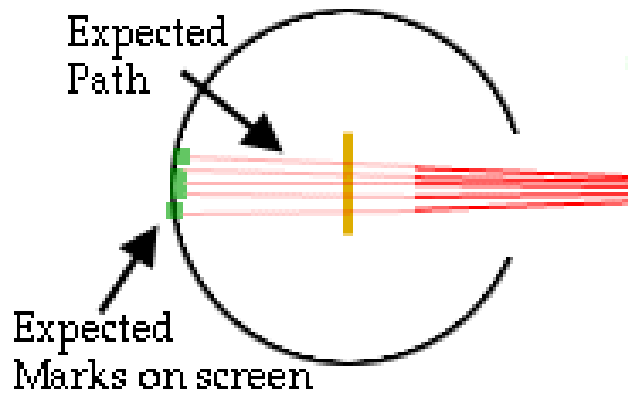

The Result:

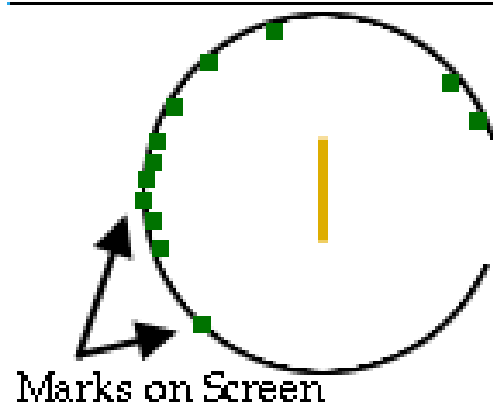

A Positive Nucleus Reflects Alpha Particles

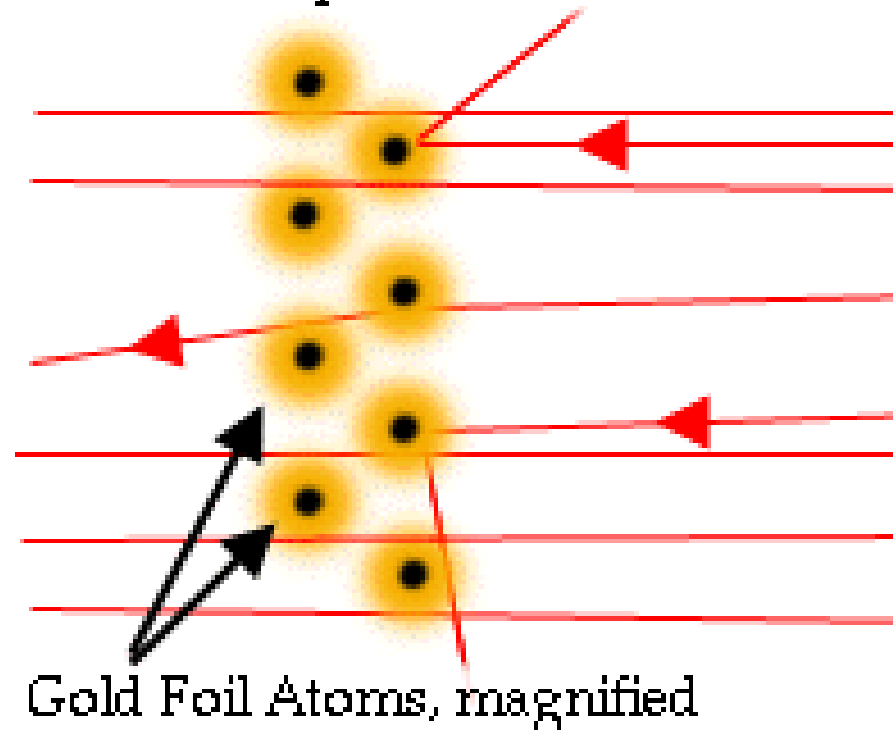

# Did Rutherford get the Nobel Prize for this?

- No, he got it in Chemistry in 1908



The Nobel Prize in Chemistry 1908  
Ernest Rutherford

**The Nobel Prize in Chemistry 1908**

Ernest Rutherford

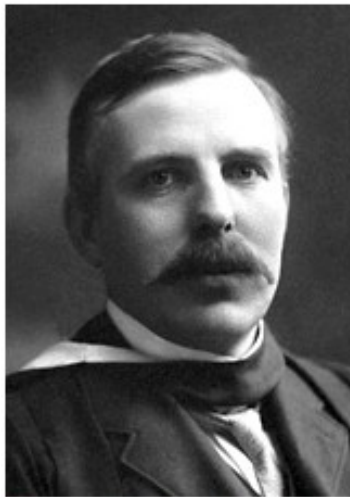

Ernest Rutherford

The Nobel Prize in Chemistry 1908 was awarded to Ernest Rutherford *"for his investigations into the disintegration of the elements, and the chemistry of radioactive substances"*.

Photos: Copyright © The Nobel Foundation

# Sources of “Beams”

## ■ Radioactive Decays

- ◆ Modest Rates
- ◆ Low Energy

## ■ Cosmic Rays

- ◆ Low Rates
- ◆ High Energy

## ■ Accelerators

- ◆ High Rates
- ◆ High Energy

# Accelerator Physics for Pedestrians

$$\vec{F} = q(\vec{E} + \vec{v} \times \vec{B}) \quad \text{Lorentz Force}$$

## ■ Electric Fields

### ACCELERATES

- ◆ Aligned with field
- ◆ Typically need very high fields

## ■ Magnetic Fields

### BENDS/CONFINES/FOCUSES

- ◆ Transverse to momentum
- ◆ Cannot change the magnitude of the momentum

# Circle or Line?

## ■ Linear Accelerator

- ◆ Electrostatic
- ◆ RF linac

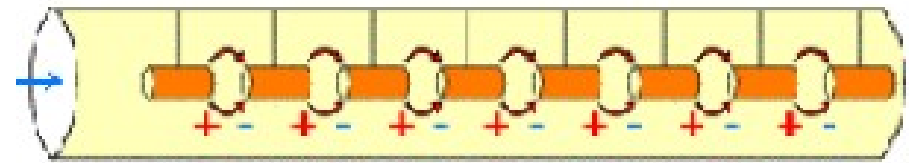

## ■ Circular Accelerator

- ◆ Cyclotron
- ◆ Synchrotron
- ◆ Storage Ring

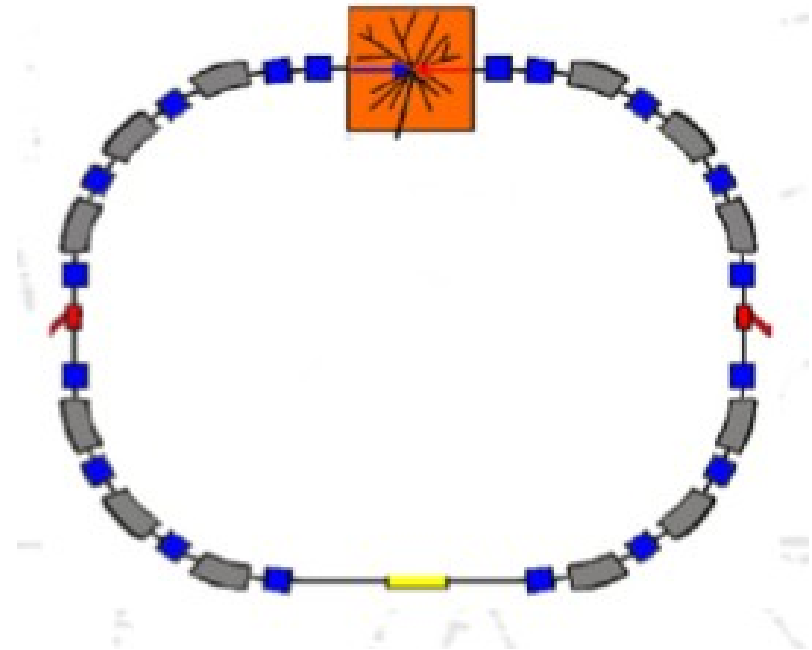

# Linear accelerators

- DC
- AC



# Cockroft-Walton - 1930s

Very nice flash interactive animation:

[http://www-outreach.phy.cam.ac.uk/camphy/cockcroftwalton/cockcroftwalton8\\_1.htm](http://www-outreach.phy.cam.ac.uk/camphy/cockcroftwalton/cockcroftwalton8_1.htm)

## Cockroft-Walton generator diagram

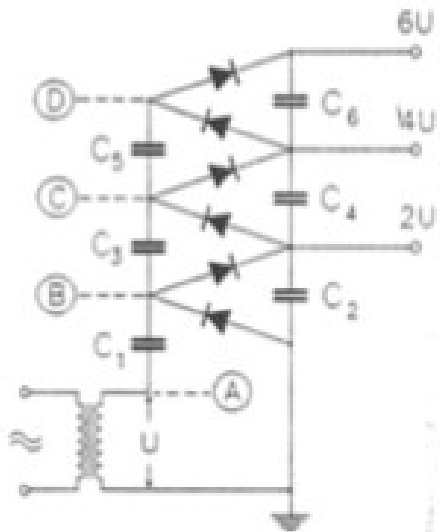

Increase voltage to  
800 kV  
(enough for nobel  
prize!)

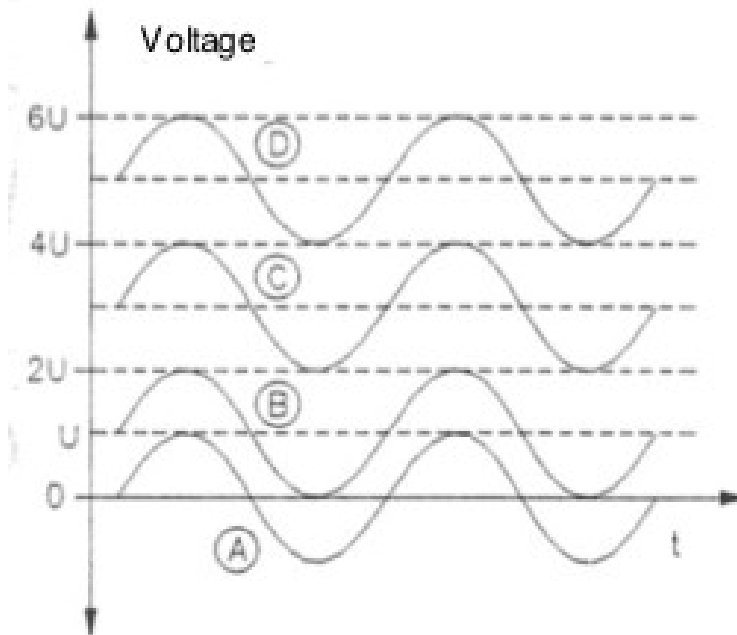



## The Nobel Prize in Physics 1951

John Cockcroft, Ernest T.S. Walton

### The Nobel Prize in Physics 1951

John Cockcroft

Ernest T.S. Walton



Sir John Douglas  
Cockcroft



Ernest Thomas Sinton  
Walton

The Nobel Prize in Physics 1951 was awarded jointly to Sir John Douglas Cockcroft and Ernest Thomas Sinton Walton *"for their pioneer work on the transmutation of atomic nuclei by artificially accelerated atomic particles"*

# Van-de Graaff - 1930s

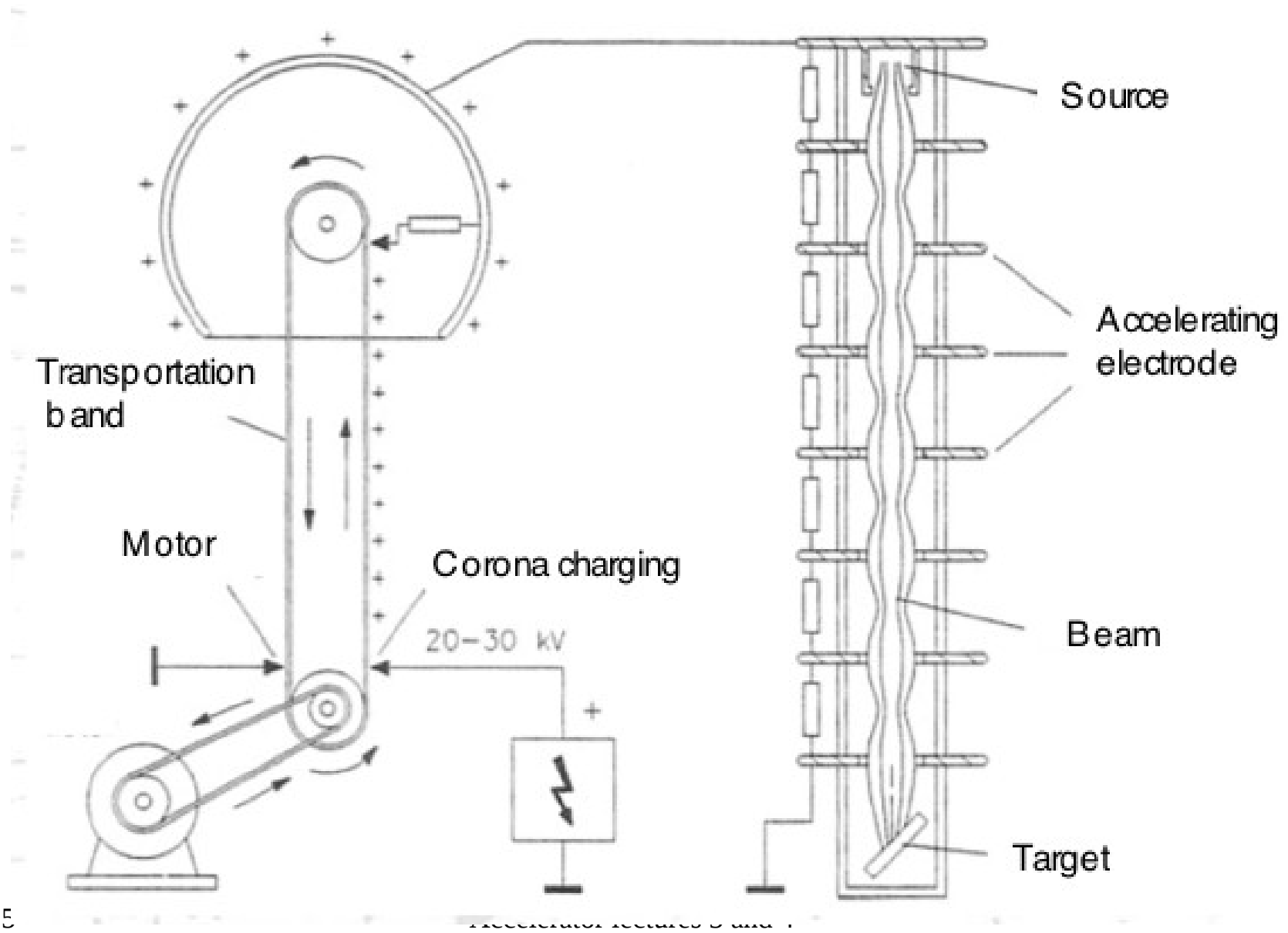

# Van-de Graaff II



First large Van-de Graaff

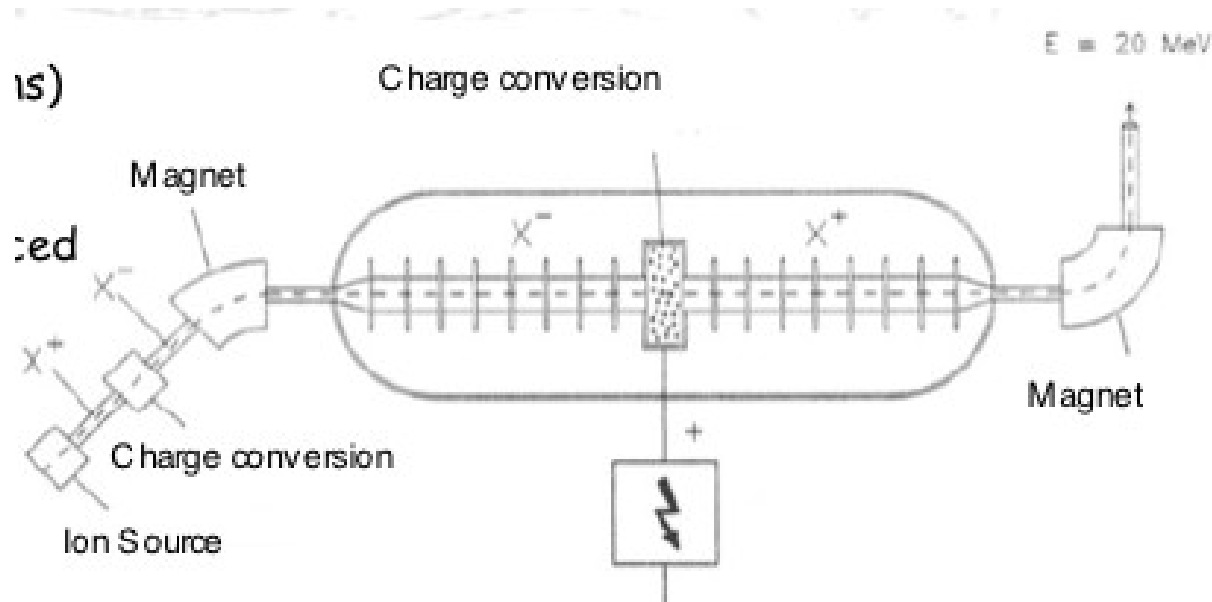

Tank allows  $\sim 10 \text{ MV}$  voltages  
Tandem allows  $\times 2$  from terminal voltage

20-30 MeV protons about the limit  
Will accelerate almost anything (isotopes)

# Gustaf Ising

## The “father” of AC acceleration

- “In 1924 Gustaf Ising, a Swedish physicist, proposed accelerating particles using alternating electric fields, with “drift tubes” positioned at appropriate intervals to shield the particles during the half-cycle when the field is in the wrong direction for acceleration. Four years later, the Norwegian engineer Rolf Wideröe built the first machine of this kind, successfully accelerating potassium ions to an energy of 50,000 electron volts (50 kiloelectron volts).”
  - From Britannica Academic Edition

# Linear Accelerators

- Proposed by Ising (Swedish) (1925)
- First built by Wideröe (Norwegian) (1928)

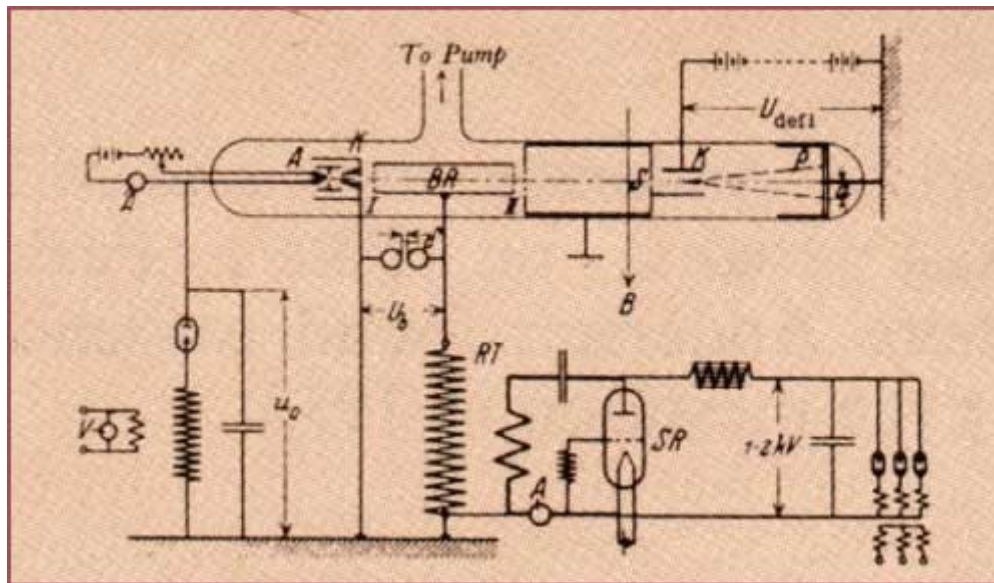

Rolf Wideröe as a young man.

# LINAC principle (1/3)

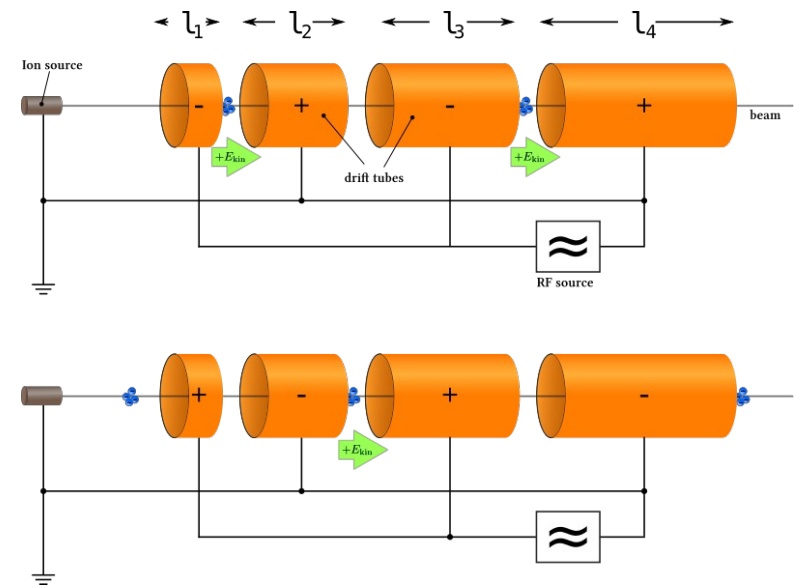

“Reuses” the acceleration voltage

# LINAC principle (2/3)

When  $v=c$ , the design is easy

For electrons this is the normal situation

Standing wave

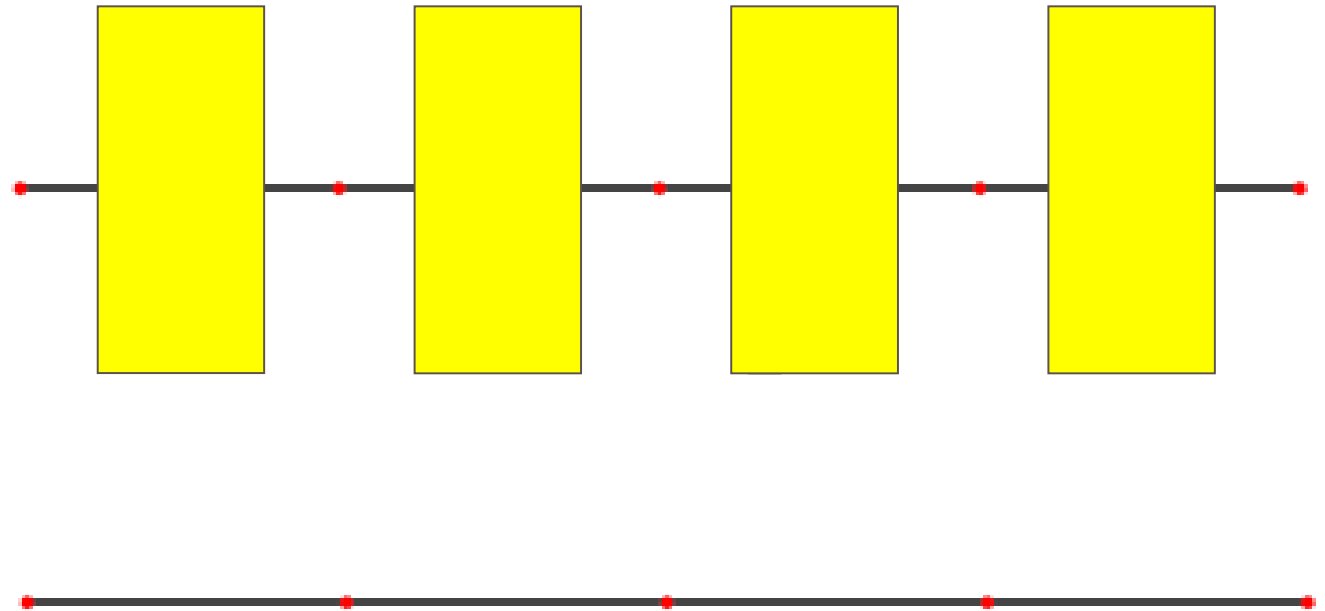



# Linac principle in action

- A small game here:

<http://www.hep.ucl.ac.uk/undergrad-projects/3rdyear/PPguide/applets/accelerator/ex.html>

# LINAC principle (3/3)

Can use a fixed frequency if  $L$  is made longer to match increase in velocity

Calculate  $L_n$  assuming  $v(\text{initial})=0$  and  $v_n$  non-relativistic and AC voltage  $U$  and frequency  $f$ :

Answer:

$$v_n = \sqrt{\frac{2neU}{m}}$$

$$\frac{1}{2f} = \frac{L_n}{v_n} \rightarrow L_n = \frac{v_n}{2f}$$

$L_n$  corresponds to half wavelength

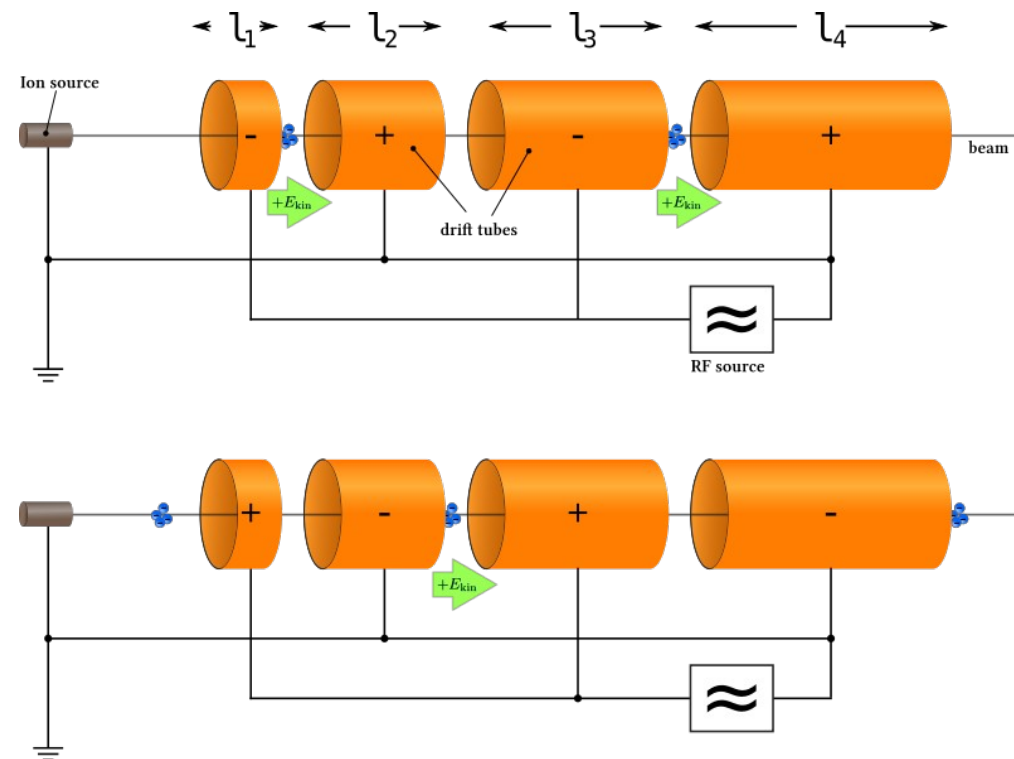

# Exercise 1.1 and 1.3

# Radio Frequency (RF) cavities for linear acceleration

- RF cavities (sometimes also called resonance cavities) are the modern way to accelerate
- The cavity works a bit similar to a LC resonance circuit creating a strong acceleration field

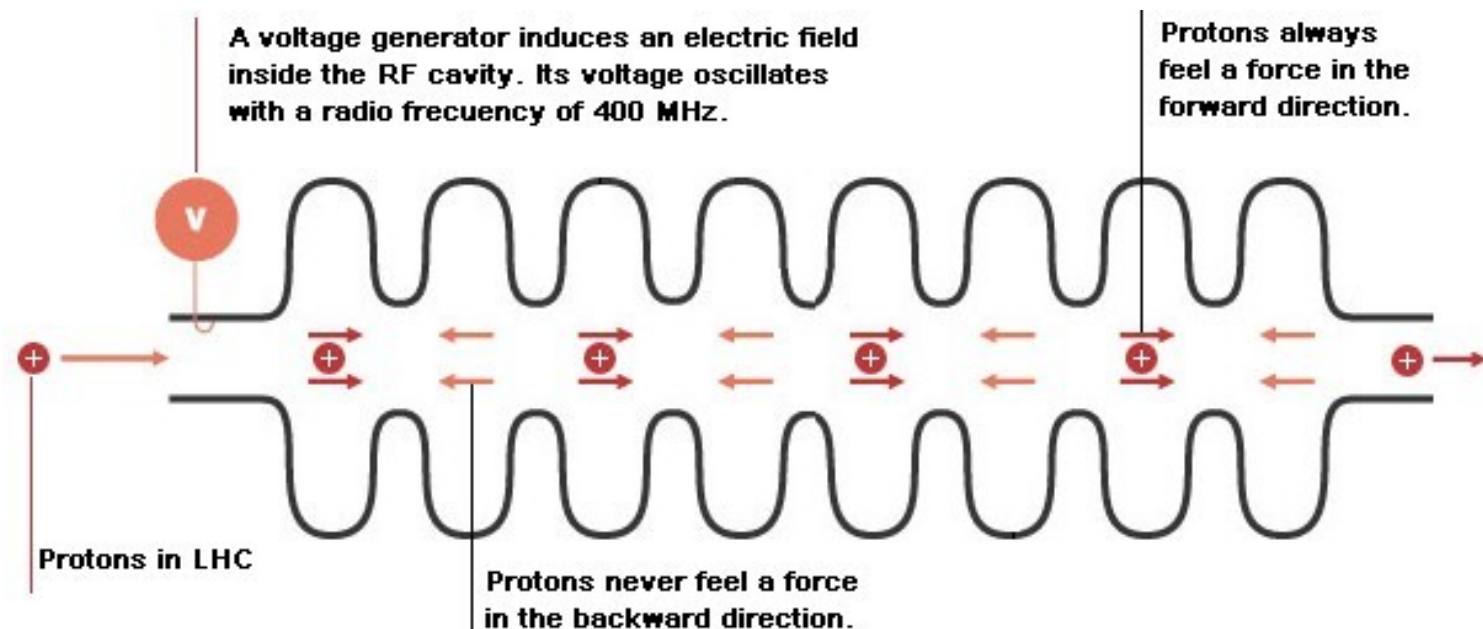

# Example of RF cavity from DESY

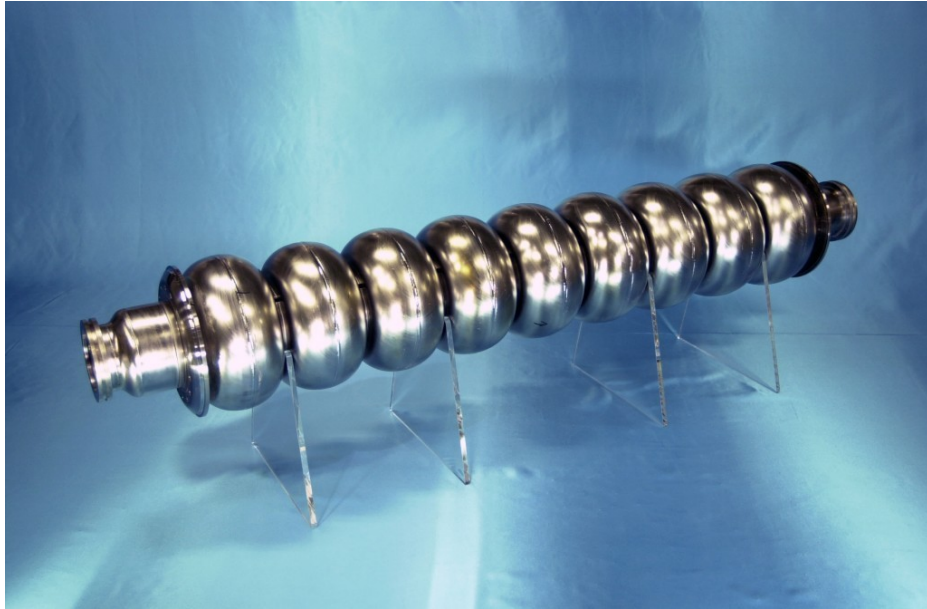

Very strong (resonant) oscillating electric field inside cavity provides acceleration

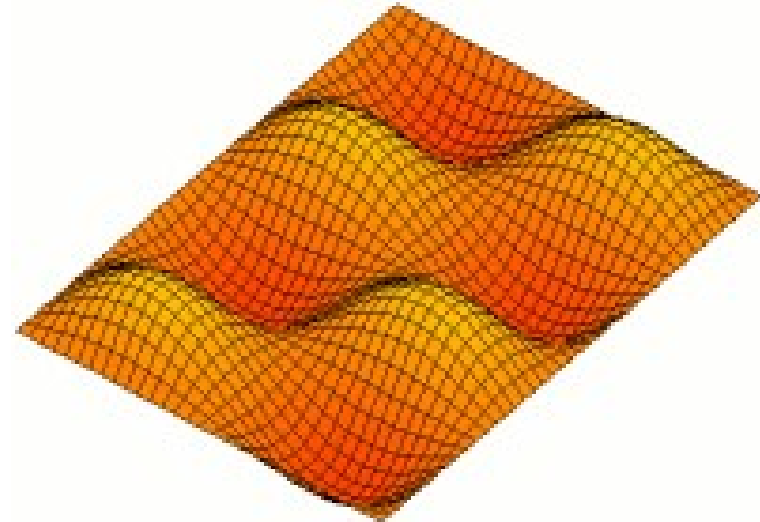

<http://en.wikipedia.org/wiki/Resonator>

- From <http://newslines.linearcollider.org/2012/11/21/major-goal-achieved-for-high-gradient-ilc-scrf-cavities/>  
“We established two gradient goals: to produce cavities qualified at 35 Megavolts per metre (MV/m) in vertical tests and to demonstrate that an average gradient of 31.5 MV/m is achievable for ILC cryomodules.”

# RF cavity at LHC

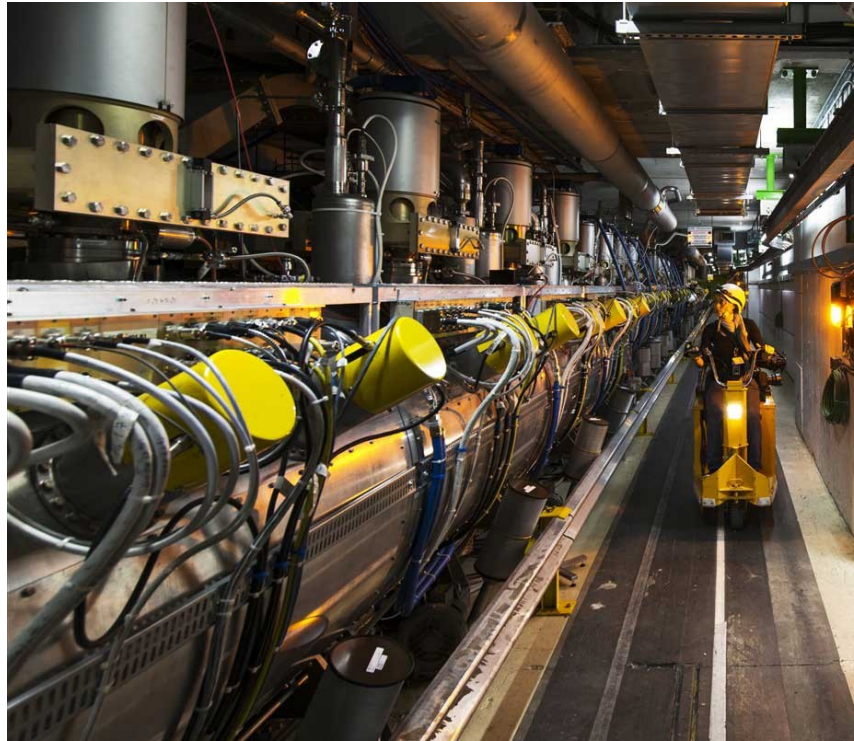

- From <http://home.web.cern.ch/about/engineering/radiofrequency-cavities>  
“High-power klystrons (tubes containing electron beams) drive each RF cavity on the LHC. A high-power electron beam inside the klystron modulates at 400 MHz. Power is extracted through a rectangular pipe of conducting metal called a waveguide, which leads to the RF cavity. Each cavity can achieve maximum voltage of 2 MV, making 16 MV per beam.”

# What is superconducting in a superconducting RF cavity?

- Answer: The inside surface => no resistance => the alternating electric field is used for pure acceleration
- From <http://home.web.cern.ch/about/engineering/radiofrequency-cavities>  
“The 16 RF cavities on the LHC are housed in four cylindrical refrigerators called cryomodules – two per beam – which keep the RF cavities working in a superconducting state, without losing energy to electrical resistance.”

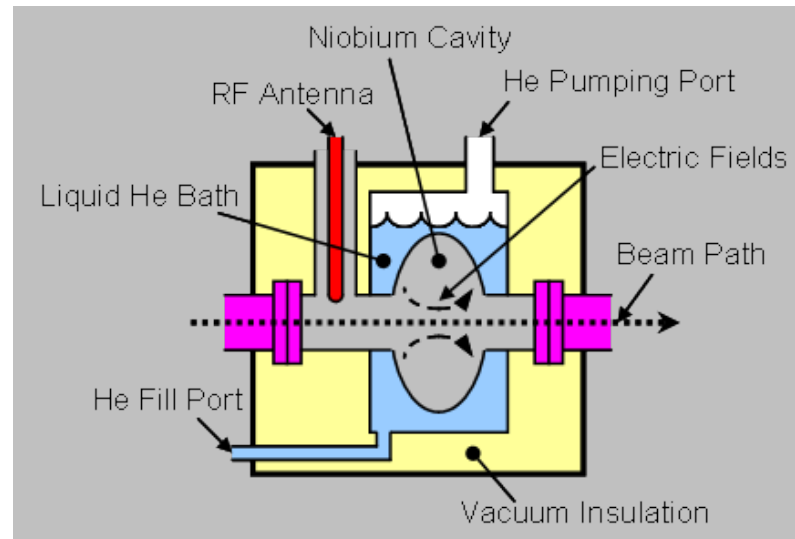



**Proposed 1 TeV  $e^+e^-$  collider**  
**Similar energy reach as LHC, higher precision**  
**International Linear Collider**



# Movies

- A linear accelerator
- <https://www.youtube.com/watch?v=cMSW5tfr5tU>
- RF cavity:
- <https://www.youtube.com/watch?v=SmgOw3qYrZc>
- Klystron:
- <https://www.youtube.com/watch?v=TsBTI3tO5-8>

# Circular acceleratos

- Only AC

# The cyclotron principle

- For a non-relativistic charged particle going around in constant ring:  $m v = q B R$
- What is the frequency of turns?
- Answer:  $f = \frac{q B}{2 \pi m}$ 
  - NB! does not depend on R

# Cyclotron

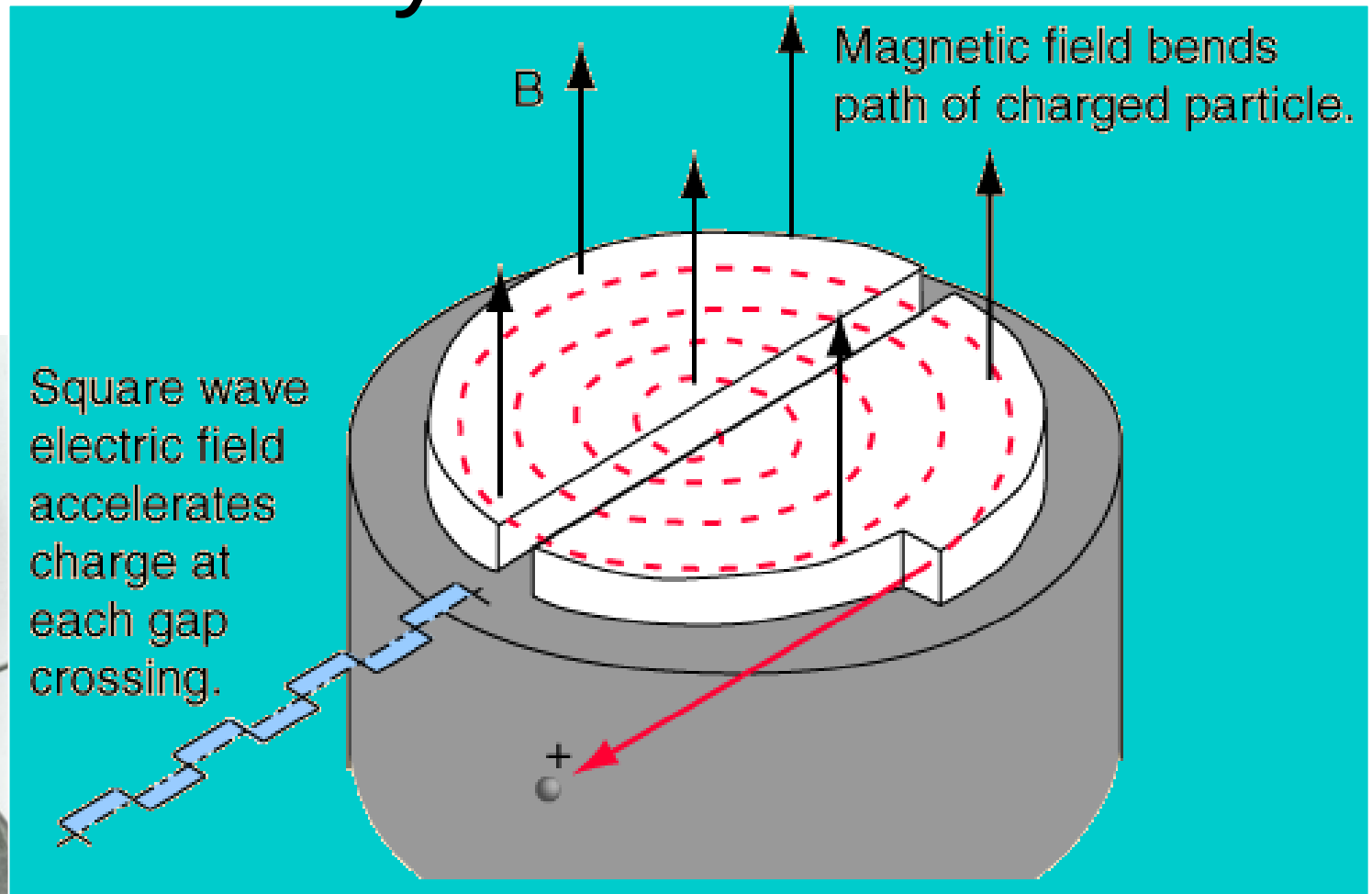
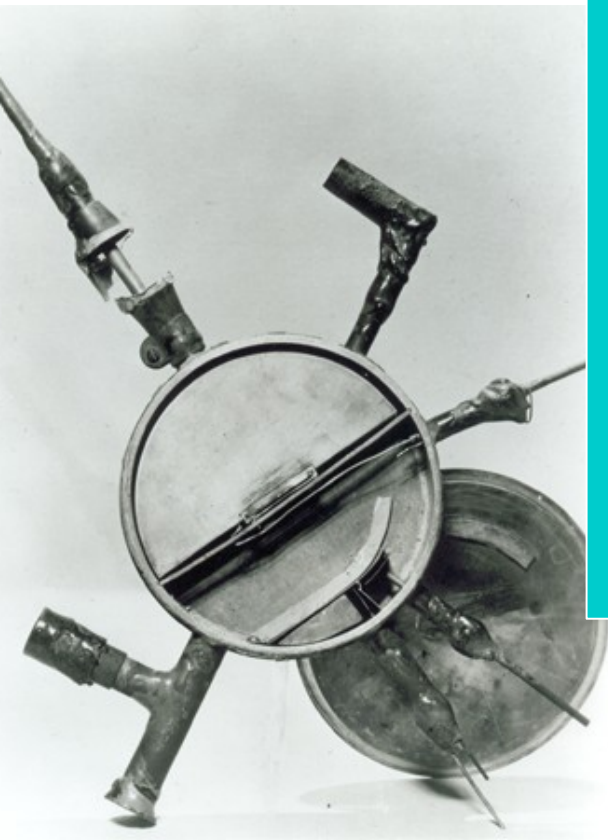

# Cyclotron animation

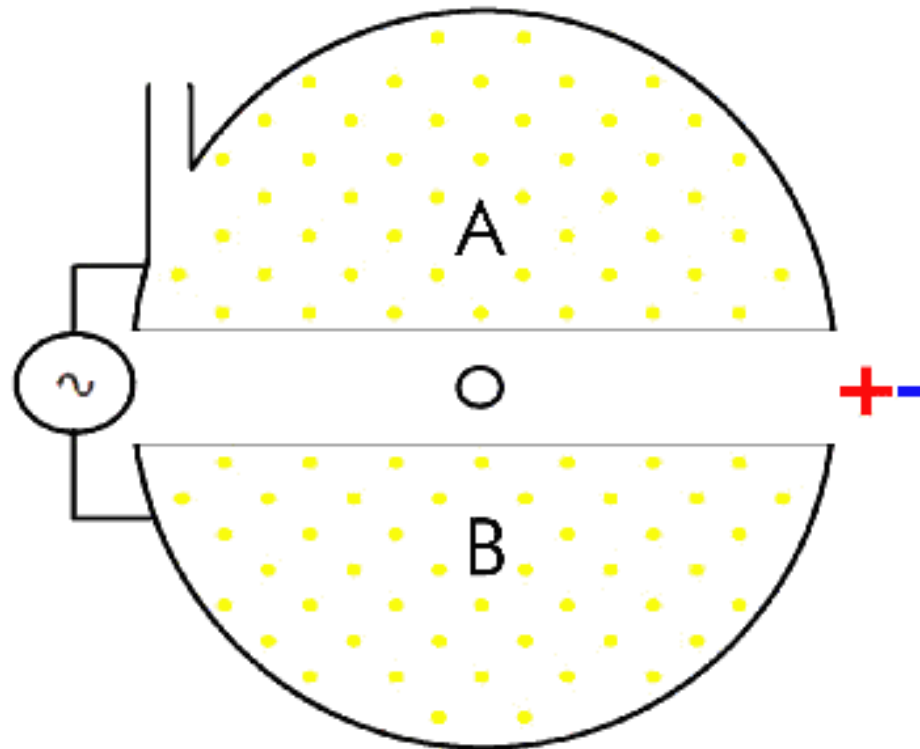

- <http://www.aip.org/history/lawrence/images/epa-animation.gif>



## The Nobel Prize in Physics 1939

### Ernest Lawrence

The Nobel Prize in Physics 1939

Ernest Lawrence



Ernest Orlando  
Lawrence

The Nobel Prize in Physics 1939 was awarded to Ernest Lawrence *"for the invention and development of the cyclotron and for results obtained with it, especially with regard to artificial radioactive elements"*.

# “Classic” Cyclotrons

Chicago, Berkeley, and others had large Cyclotrons (e.g.: 60” at LBL) through the 1950s

Protons, deuterons, He to ~20 MeV

Typically very high currents, fixed frequency

$$B [T] \cdot R [m] = 0.3 \cdot p [GeV/c]$$

$$\omega = \frac{e}{m} \cdot B$$



Higher energies limited by shift in revolution frequency due to relativistic effects. Cyclotrons still used extensively in hospitals.

# Synchrocyclotron

- Fixed “classic” cyclotron problem by adjusting “Dee” frequency.
- No longer constant beams, but rather injection+acceleration
- Up to 700 MeV eventually achieved

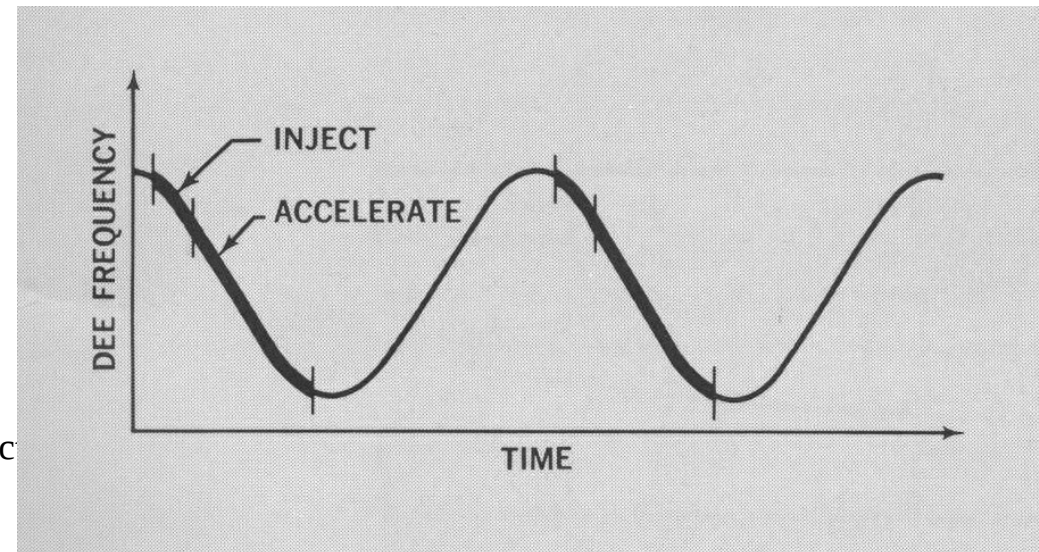
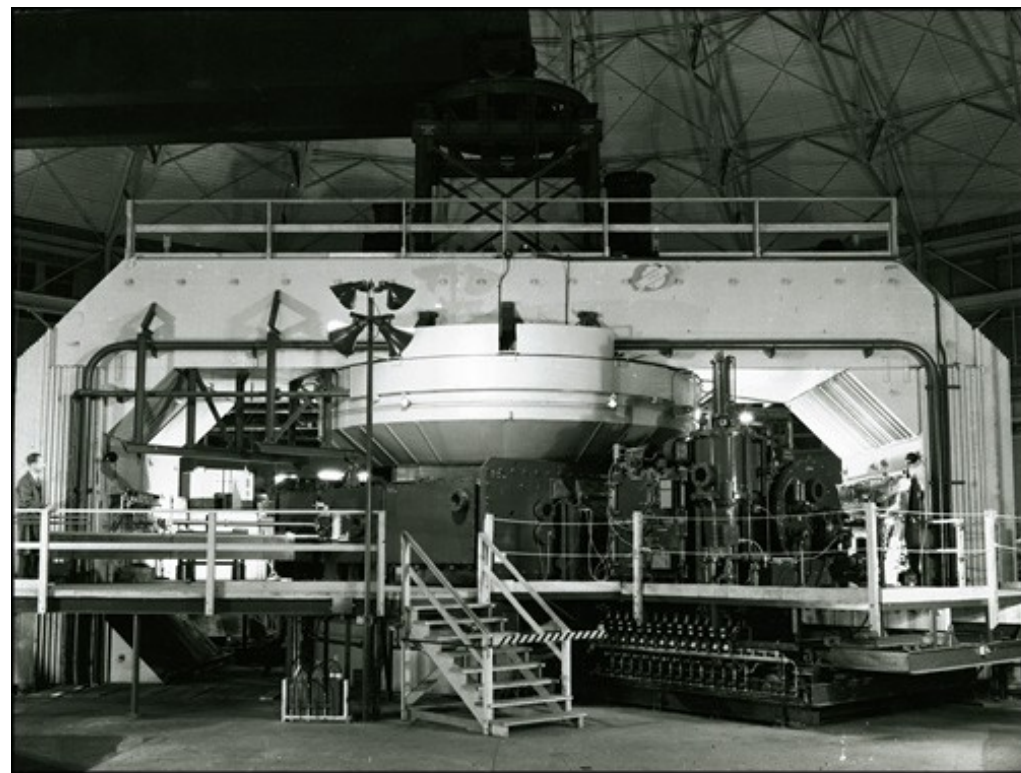



# Other alternative to solve relativistic problem

- One also has solution where one modifies  $B(r)$  to take into account relativistic effects
- The advantage is that then one can still have continuous beam

# Betatron: an outsider

- The betatron was developed as a circular accelerator for electrons (where the cyclotron fails due to the relativistic effects)
- “A betatron is a cyclic particle accelerator developed by Donald Kerst at the University of Illinois in 1940 to accelerate electrons, but the concepts ultimately originate from Rolf Widerøe, whose development of an induction accelerator failed due to the lack of transverse focusing. Previous development in Germany also occurred through Max Steenbeck in the 1930s.”, <http://en.wikipedia.org/wiki/Betatron>

# Betatron: principle

- In a betatron the acceleration field is the induced electric field from varying the magnetic field (time dependence)
- Note that the same magnetic field is used to confine the particles!

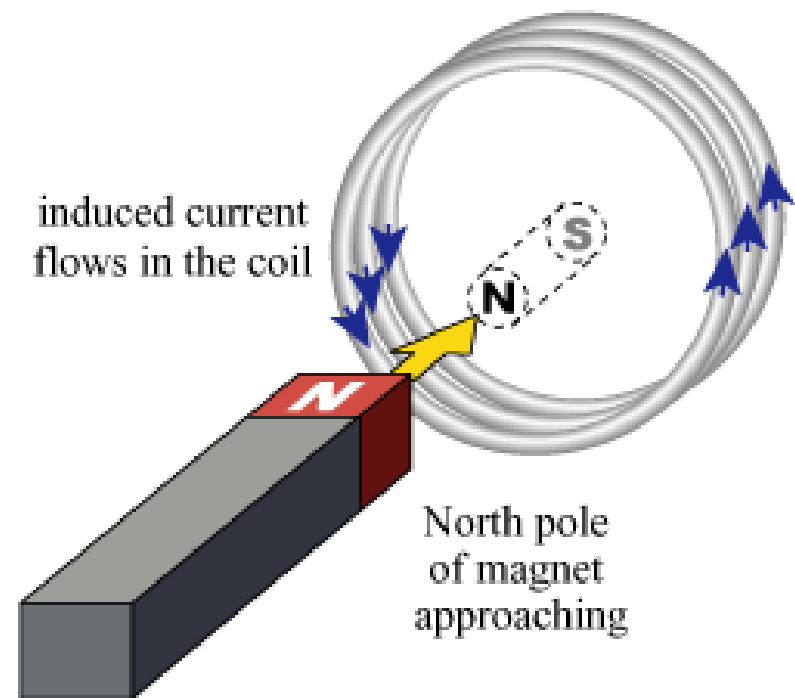

# How does it look and work

Dobald Kerst with first betatron



300 MeV betatron ~1950

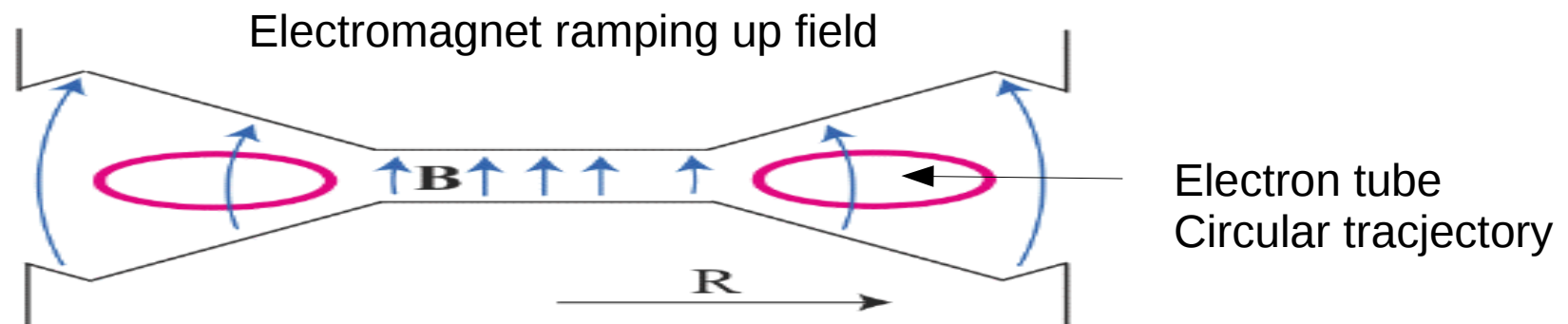
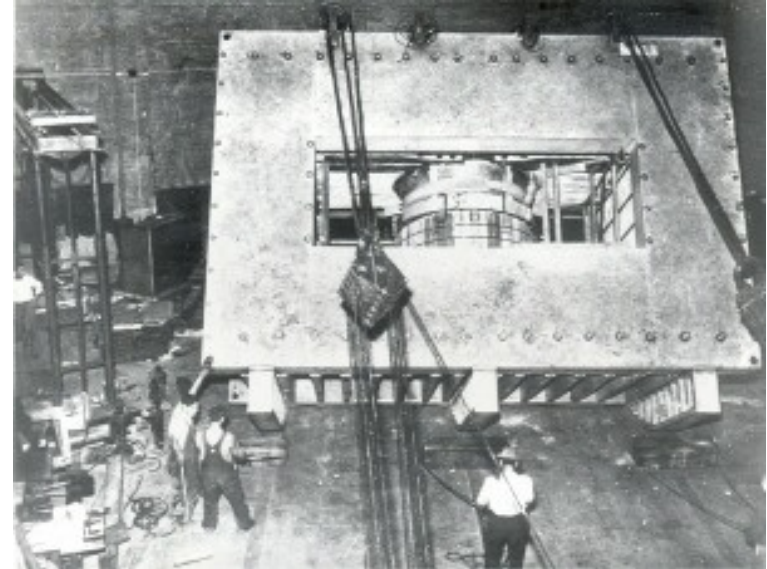

Nice animation:

<http://einstein1.byu.edu/~masong/emsite/S4Q50/betatron.html>

# Towards the Synchrotron

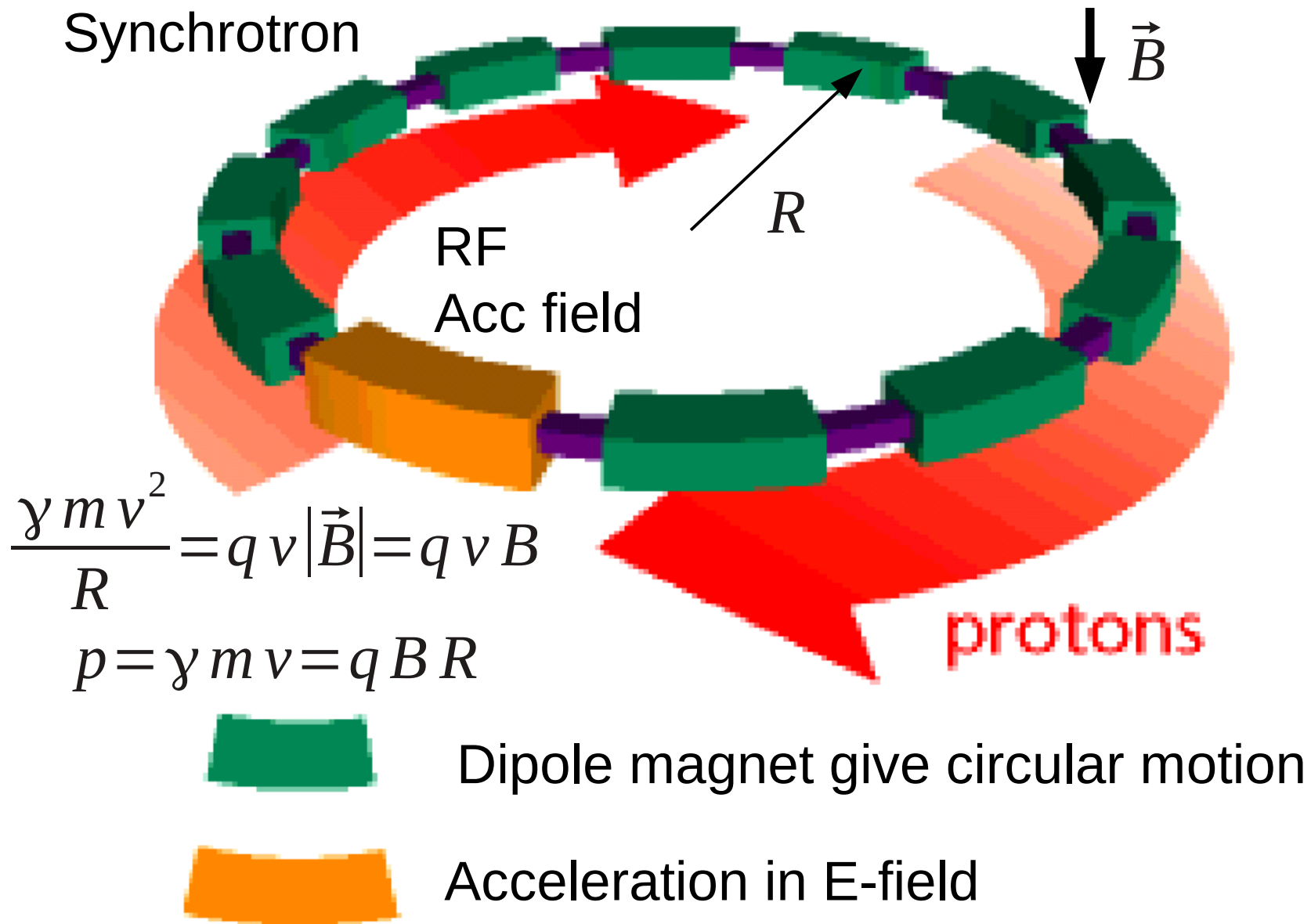

# How the AC acceleration helps to focus the beam in bunches

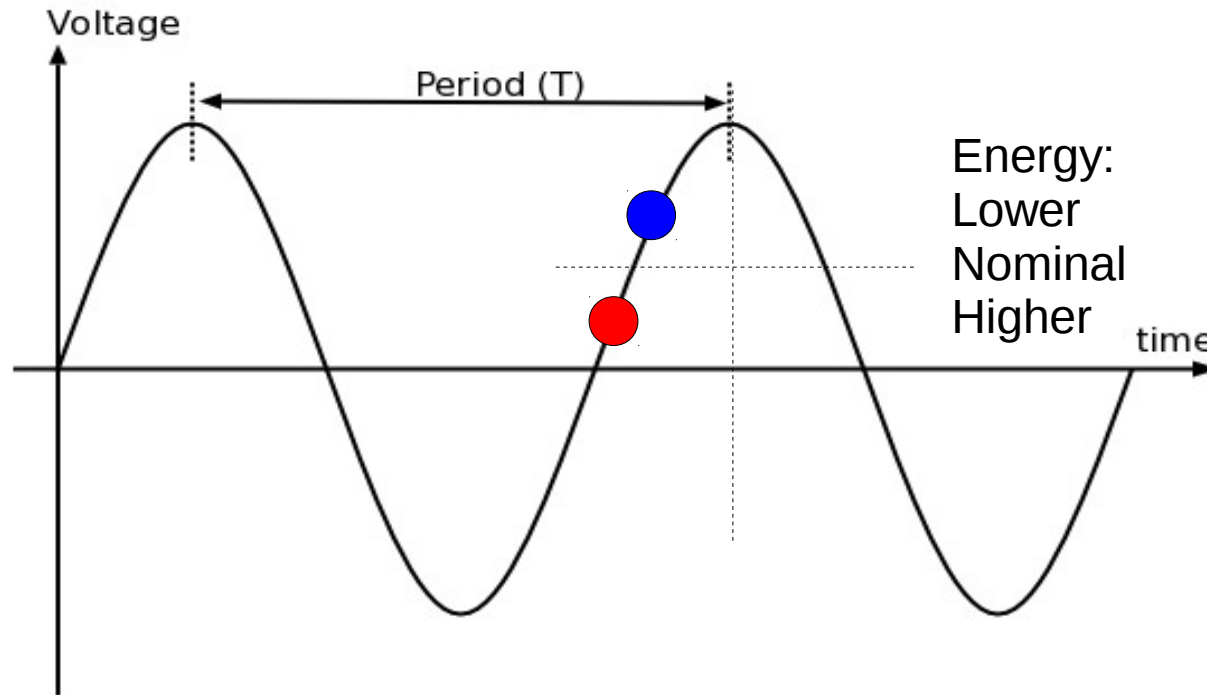

- We want to align the beam so that slower particles see a bigger acceleration voltage than faster particles
- In that way the longitudinal momentum dispersion in the beam will be reduced

# The particles are “surfing” the acceleration wave

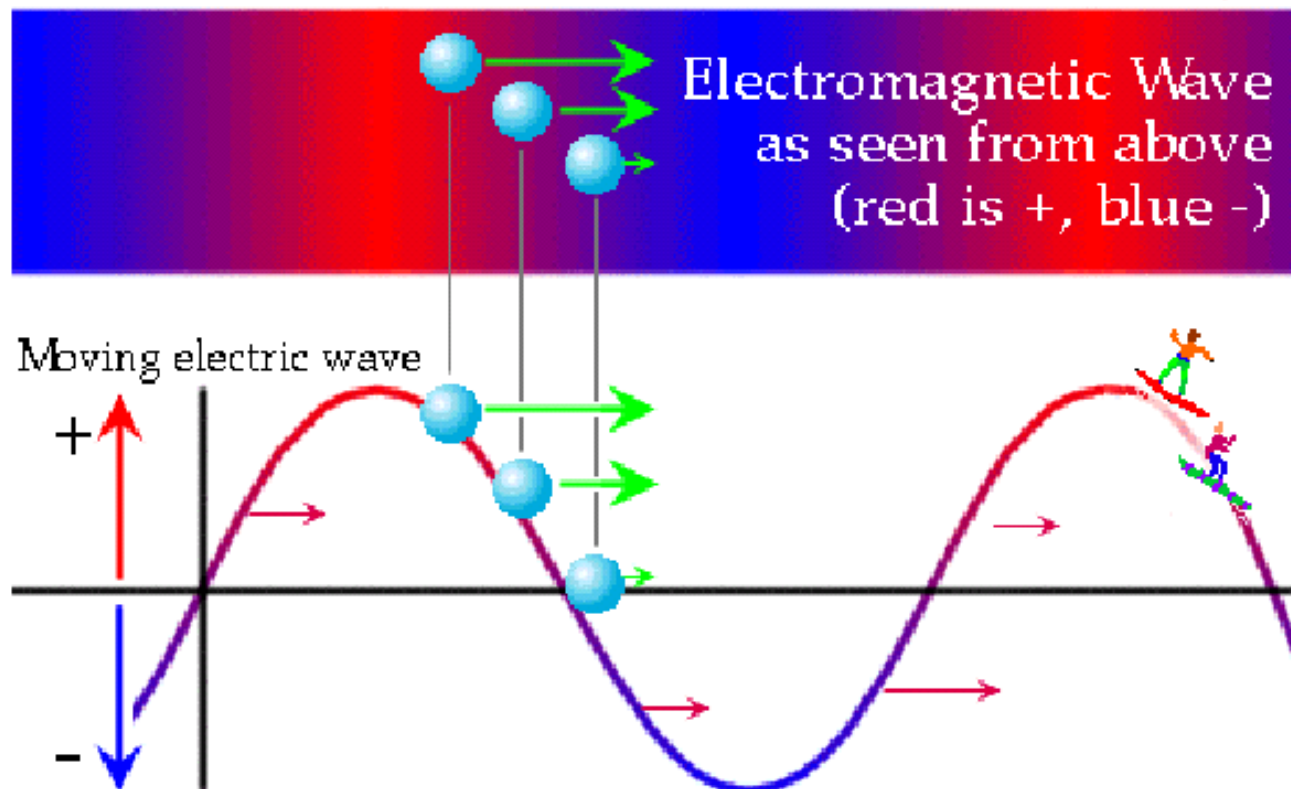
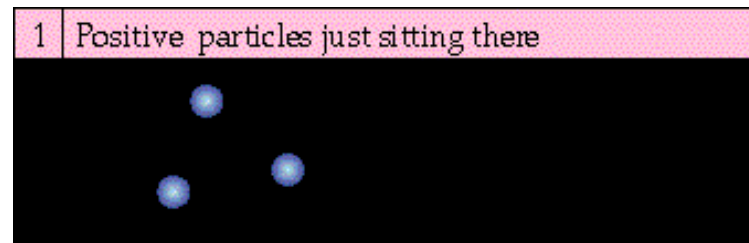

# Problem

- What happens when  $v \sim c$ ?
  - Why do the more energetic particles take longer to go around?!
- Answer:
  - Larger radius (longer path length) for same B field!

$$R = \frac{p}{qB}$$
$$f = \frac{v}{2\pi R} = \frac{qBc}{2\pi p}$$

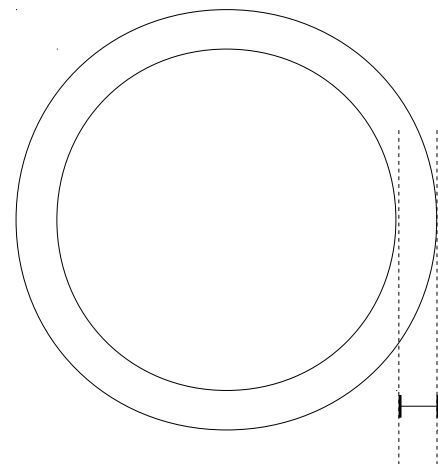

$$\Delta p > 0 \rightarrow \Delta R > 0$$



# The transition energy

- The energy at which the higher (lower) energy particles in the beam starts to go slower (faster) around than nominal energy particles is called the transition energy
- Need to “invert” longitudinal focusing = shift half a wavelength
  - Technically challenging as beam focus diverges

